

Portofoliu

Denumire produs: Cupa escavat 2503 L=300,400mm

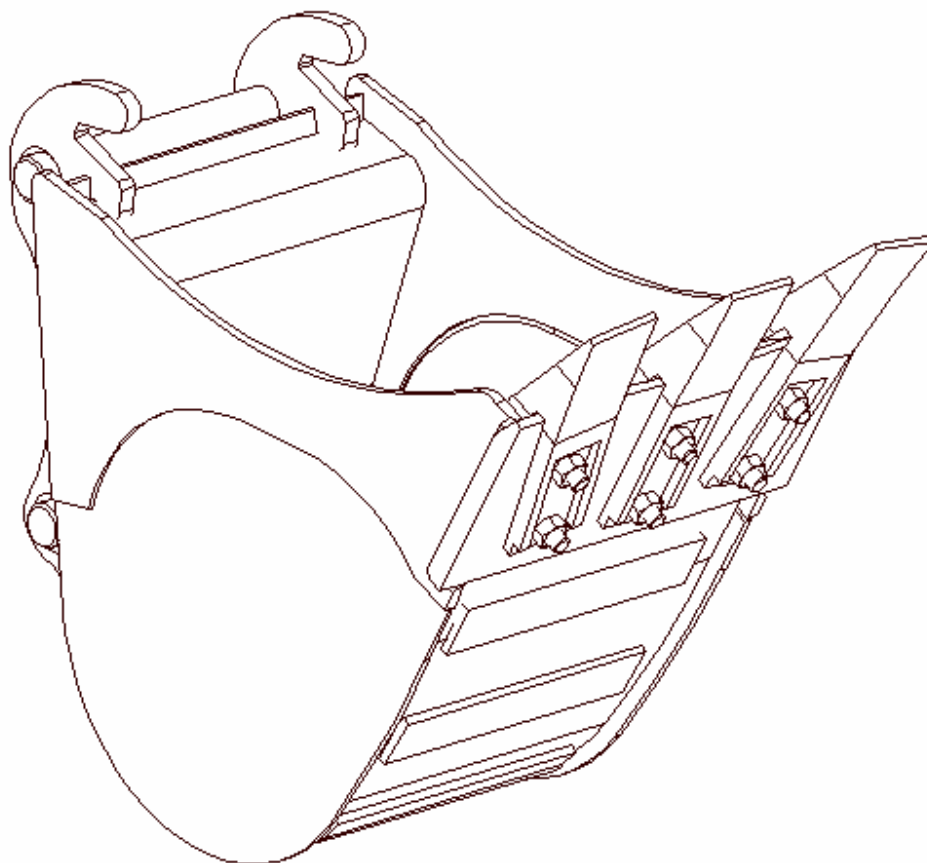

Latime gabarit (mm)	Greutate (Kg.)	Volum (l.)	Calitate material	Dinti	Nr. dinti	Bolt* (mm)	Cutit frontal (mm)
300	43	42	OL 52	CATERPILAR E20.5	3	Ø30 L=227	HARDOX 16X150X300
400	50	56	OL 52	CATERPILAR E20.5	3	Ø30 L=227	HARDOX 16X150X400

*Sistemul de cuplare va fi adaptat utilajului clientului.