

Portofoliu

Denumire produs: Cupa escavat 2503 L=500,600mm

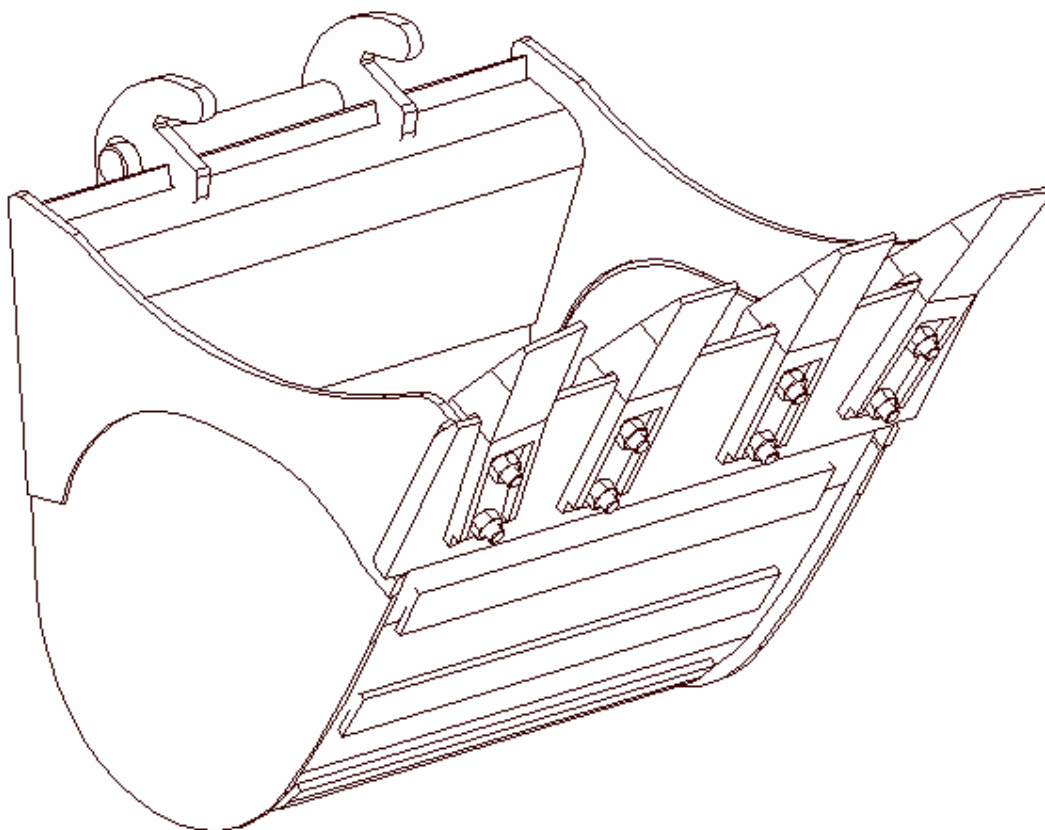

Latime gabarit (mm)	Greutate (Kg.)	Volum (l.)	Calitate material	Dinti	Nr. dinti	Bolt* (mm)	Cutit frontal (mm)
500	60	70	OL 52	CATERPILAR E20.5	4	Ø30 L=227	HARDOX 16X150X500
600	78	84	OL 52	CATERPILAR E20.5	4	Ø30 L=227	HARDOX 16X150X600

*Sistemul de cuplare va fi adaptat utilajului clientului.