

Portofoliu

Denumire produs: Cupa escavat 50Z3 L=350,400mm

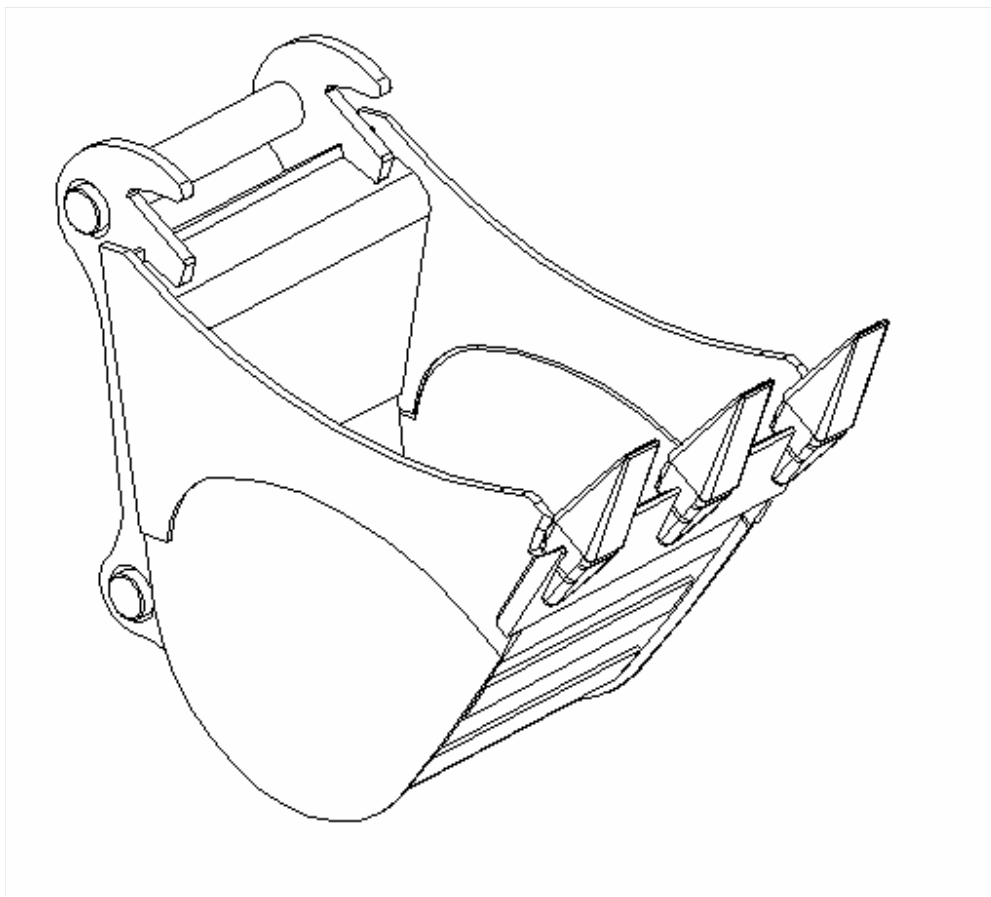

Latime gabarit (mm)	Greutate (Kg.)	Volum (l.)	Calitate material	Dinti	Nr. dinti	Bolt* (mm)	Cutit frontal (mm)
350	98	95	OL 52	CATERPILAR E350	3	Ø50 L=323	HARDOX 20x150x356
400	116	140	OL 52	CATERPILAR E350	3	Ø50 L=333	HARDOX 20x150x400

*Sistemul de cuplare va fi adaptat utilajului clientului.